

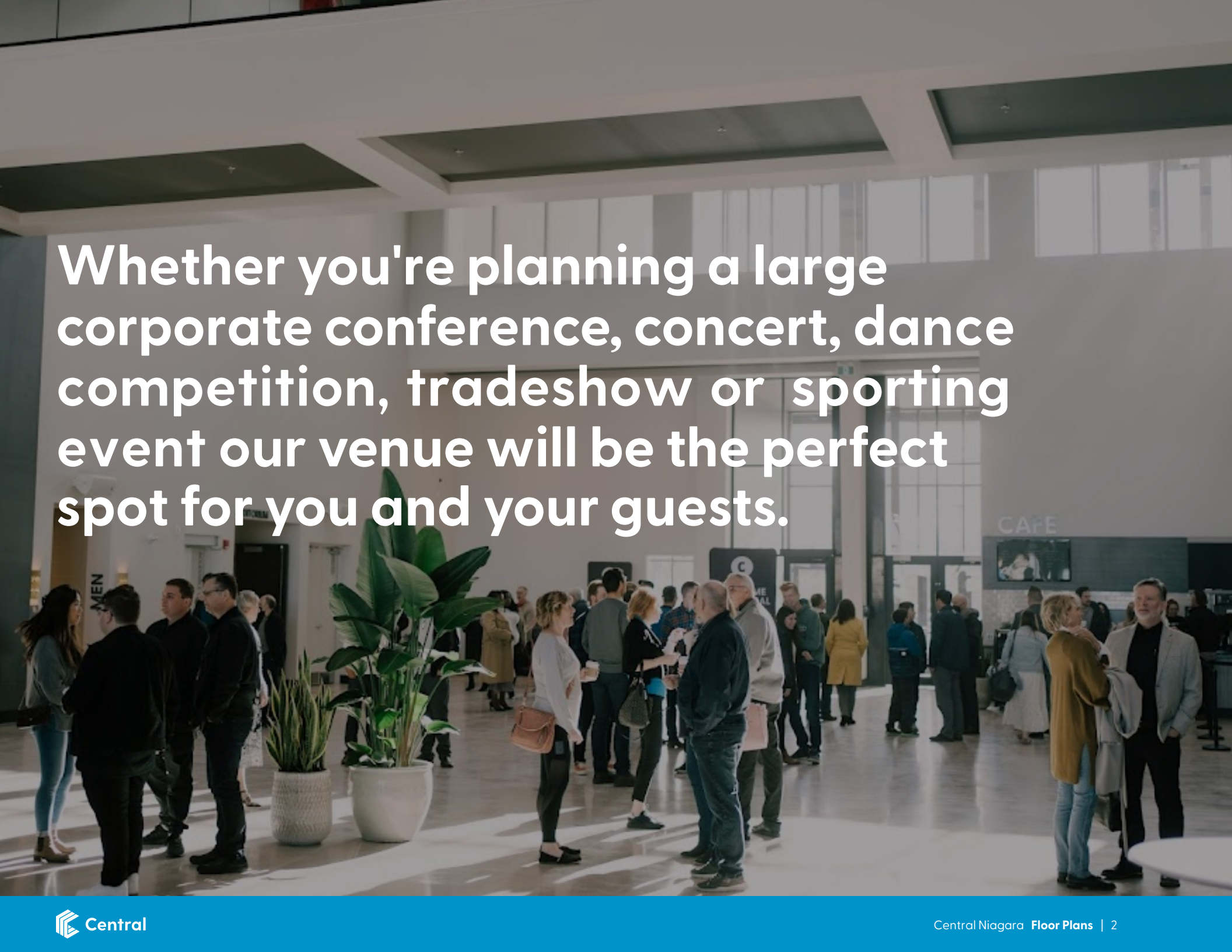

# Multi-Purpose Building Floor Plans

Version 1.1 | Updated August 2024



Whether you're planning a large corporate conference, concert, dance competition, tradeshow or sporting event our venue will be the perfect spot for you and your guests.

# Ground Floor Plan

- 1 Auditorium ▶
- 2 Multipurpose Room B ▶
- 3 Lobby Area ▶
- 4 Café Area ▶
- 5 Auditorium B ▶
- 6 Multipurpose Room A ▶
- 7 Greenroom B ▶
- 8 Greenroom A ▶

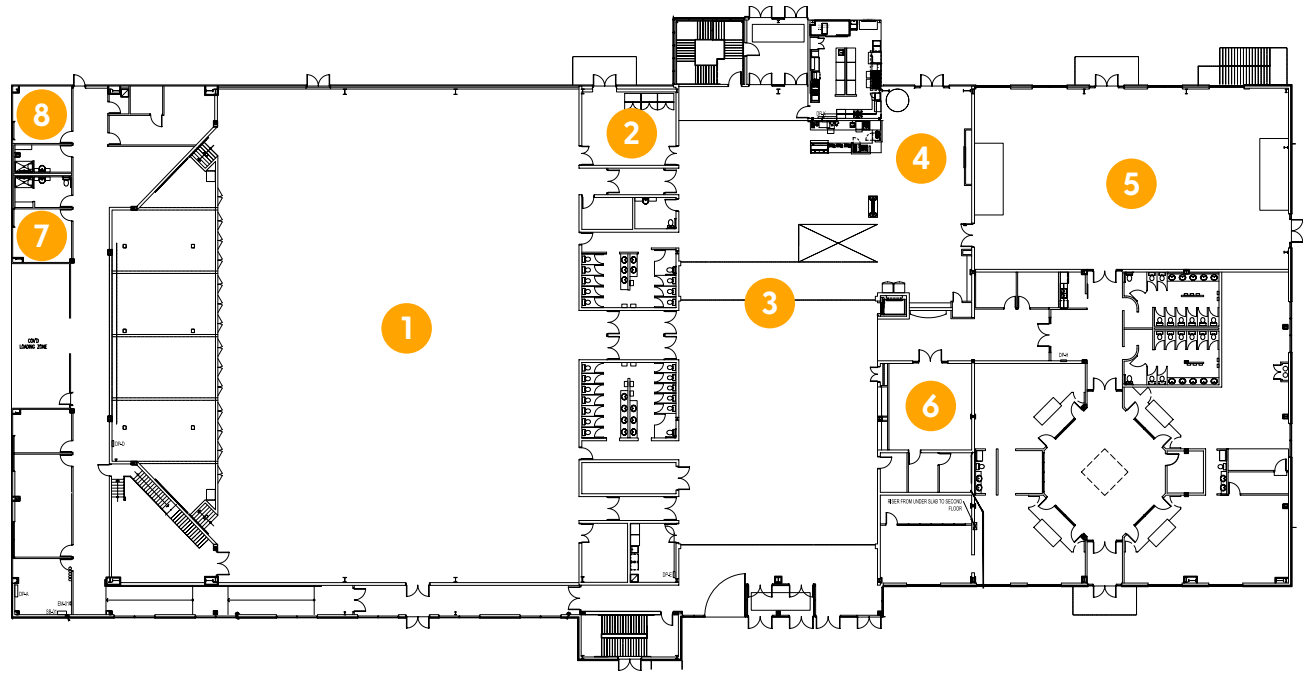

# Upper Floor Plan

- 1 Meeting Room A ▶
- 2 Meeting Room B ▶
- 3 Meeting Room C ▶
- 4 Meeting Room D ▶
- 5 Meeting Room E ▶
- 6 Executive Boardroom ▶
- 7 Future Rental Space ▶

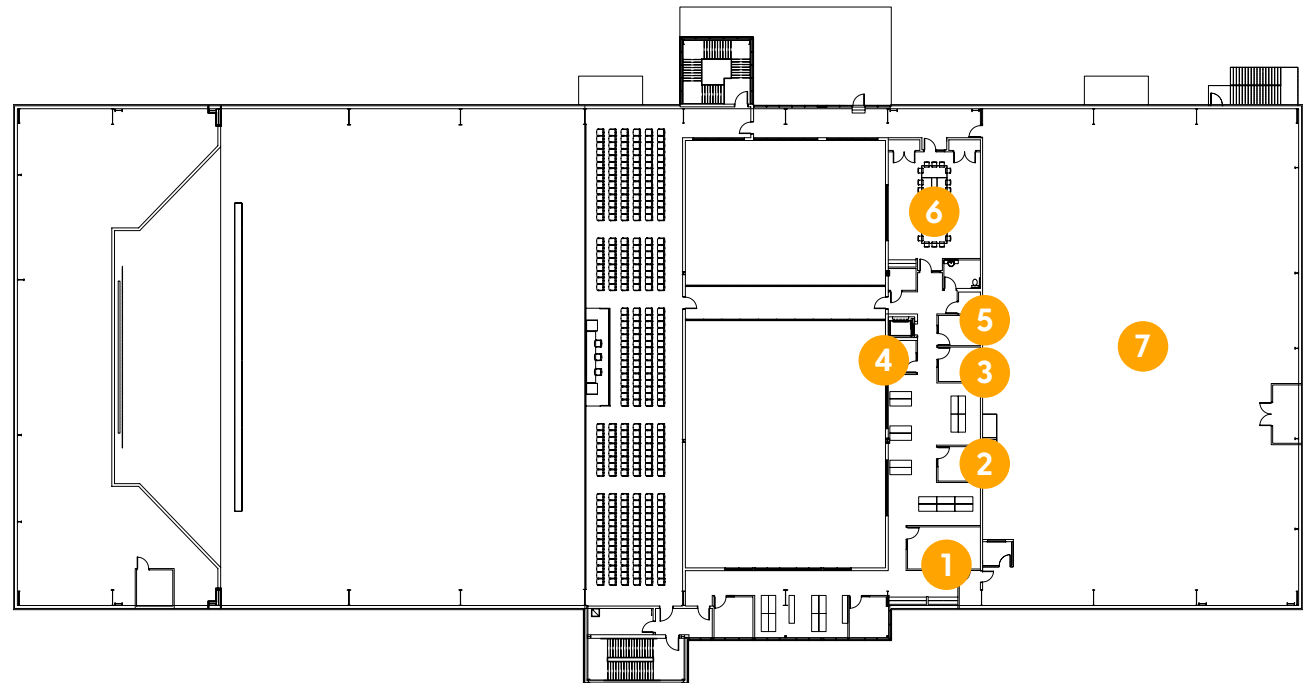

## Auditorium

If you are looking to host a concert, tradeshow, conference or sporting event, our Main Auditorium will be the room to WOW your guests. Boasting over 13,000 sqft, state of the art Meyer sound system and large stage this auditorium is a show stopper.

Rentals include onsite technicians and camera crew (if requested), balcony, greenroom, backstage and lobby.

### Primary Use:

- + Conferences
- + Tradeshows
- + Concerts
- + Volleyball
- + Basketball
- + Receptions/Gala

[Multipurpose Room B](#) ▶

[Lobby Area](#) ▶

[Café Area](#) ▶

[Auditorium B](#) ▶

[Multipurpose Room A](#) ▶

[Greenroom B](#) ▶

[Greenroom A](#) ▶

[Explore: Upper Floor Plan](#) ▶

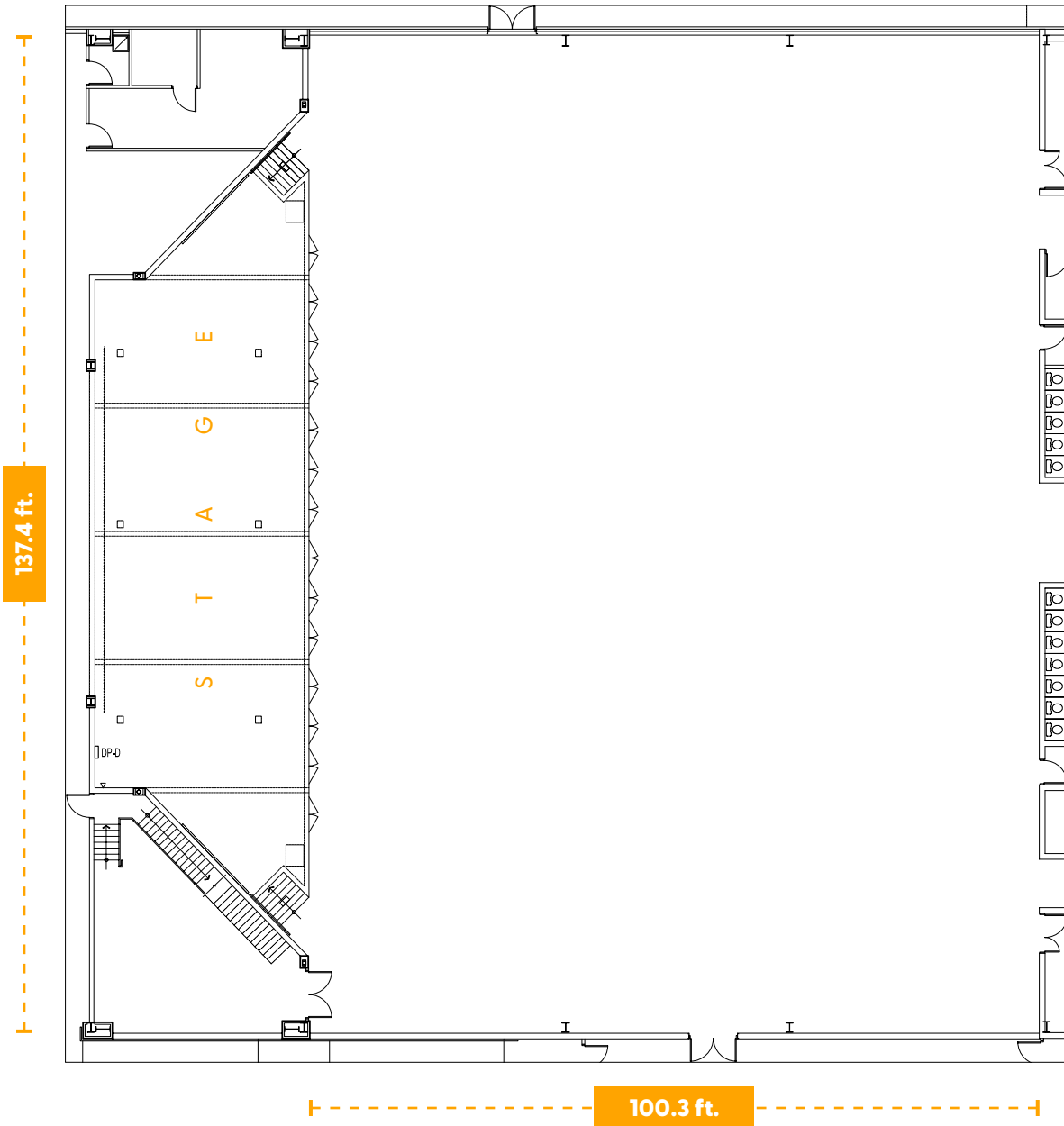

Ground Floor Plan

Auditorium

## Multipurpose Room B

If you are looking for a breakout room for conferences or need a daily meeting space for a small get together. This Multipurpose Room has easy access being located on our main room, right off our grand lobby.

### Primary Use:

- + Conference Breakout Addon
- + Daily meeting rental

[Auditorium](#) ▶

[Lobby Area](#) ▶

[Café Area](#) ▶

[Auditorium B](#) ▶

[Multipurpose Room A](#) ▶

[Greenroom B](#) ▶

[Greenroom A](#) ▶

[Explore: Upper Floor Plan](#) ▶

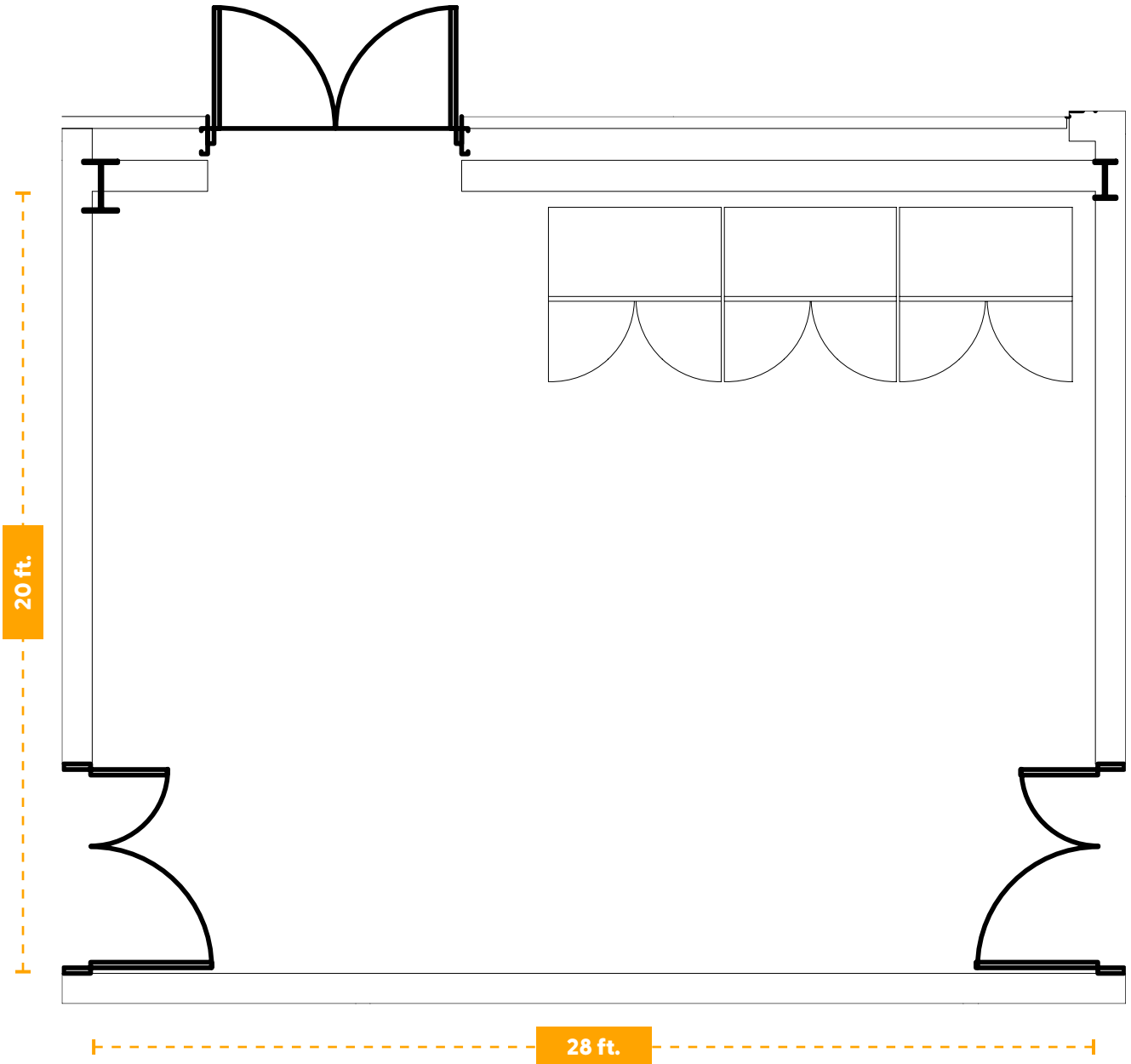

Ground Floor Plan

Multipurpose Room B

## Lobby Area

Our grand lobby is a site to behold. With floor to ceiling windows this area is the spot to host a reception or tradeshow event. If you are requesting our Main Auditorium or Auditorium B your guests have access to our lobby area as well.

### Primary Use:

- + Reception
- + Welcome area
- + Tradeshow

[Auditorium](#) ▶

[Multipurpose Room B](#) ▶

[Café Area](#) ▶

[Auditorium B](#) ▶

[Multipurpose Room A](#) ▶

[Greenroom B](#) ▶

[Greenroom A](#) ▶

[Explore: Upper Floor Plan](#) ▶

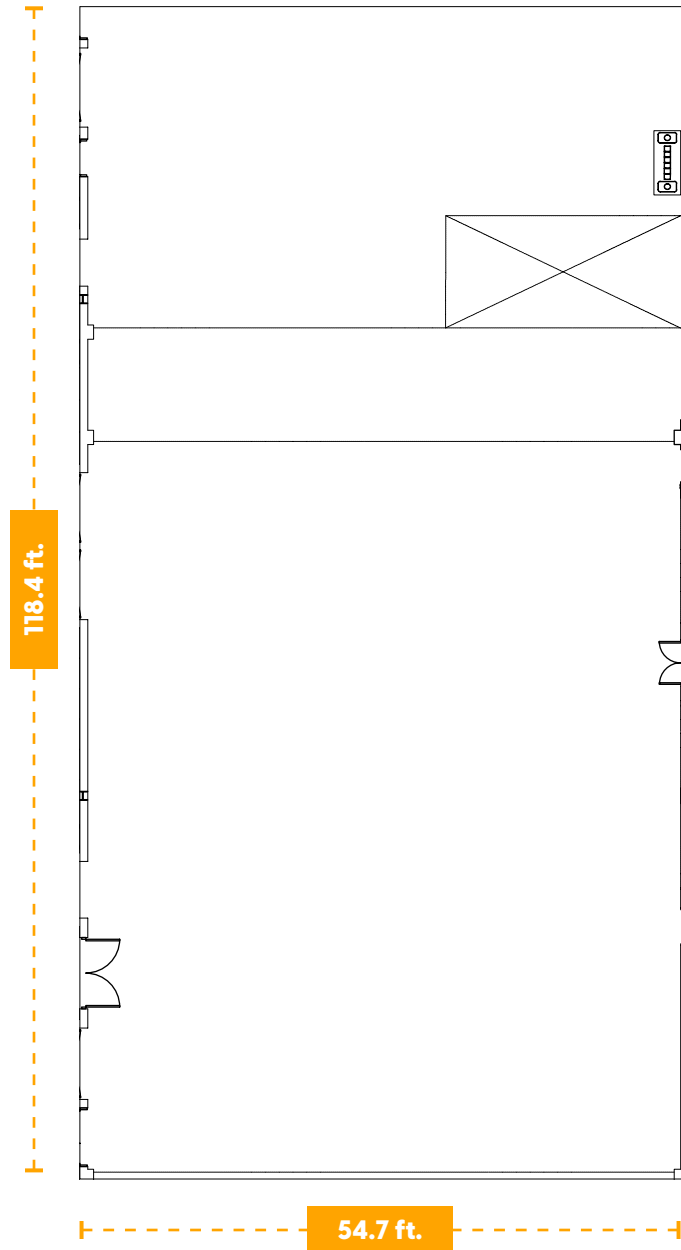

Ground Floor Plan

Lobby Area

## Café Area

Our cafe area includes both soft seating and table and chairs that can be used to host small meetings. It is available for use as part of your conference rentals as additional seating.

If requested our Community Crew Cafe is available to host your guests. Proceeds from sales go to support their Lunch and Afterschool Programs, which provides lunches enriching activities each week to students in schools throughout the Niagara Region.

[Auditorium ▶](#)

[Multipurpose Room B ▶](#)

[Lobby Area ▶](#)

[Auditorium B ▶](#)

[Multipurpose Room A ▶](#)

[Greenroom B ▶](#)

[Greenroom A ▶](#)

[Explore: Upper Floor Plan ▶](#)

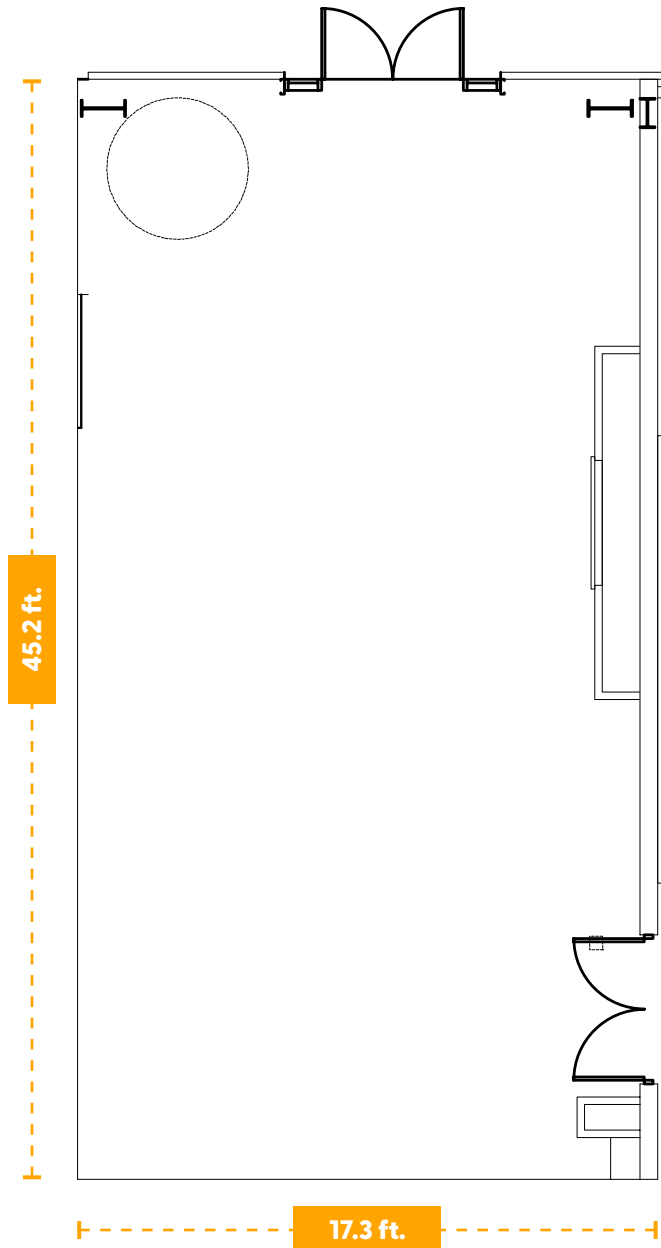

Ground Floor Plan

Café Area

## Auditorium B

Whether you are looking for a room to host a conference, private event or life event like a wedding or funeral, Auditorium B could be the perfect room for your guests. With over 3,600 sqft feet of meeting space, floor to ceiling windows, high ceilings and state of the art audio visual including screens. Seating available up to 300 people.

### Primary Use:

- + Conferences
- + Reception
- + Funerals
- + Meetings

[Auditorium](#) ▶

[Multipurpose Room B](#) ▶

[Lobby Area](#) ▶

[Café Area](#) ▶

[Multipurpose Room A](#) ▶

[Greenroom B](#) ▶

[Greenroom A](#) ▶

[Explore: Upper Floor Plan](#) ▶

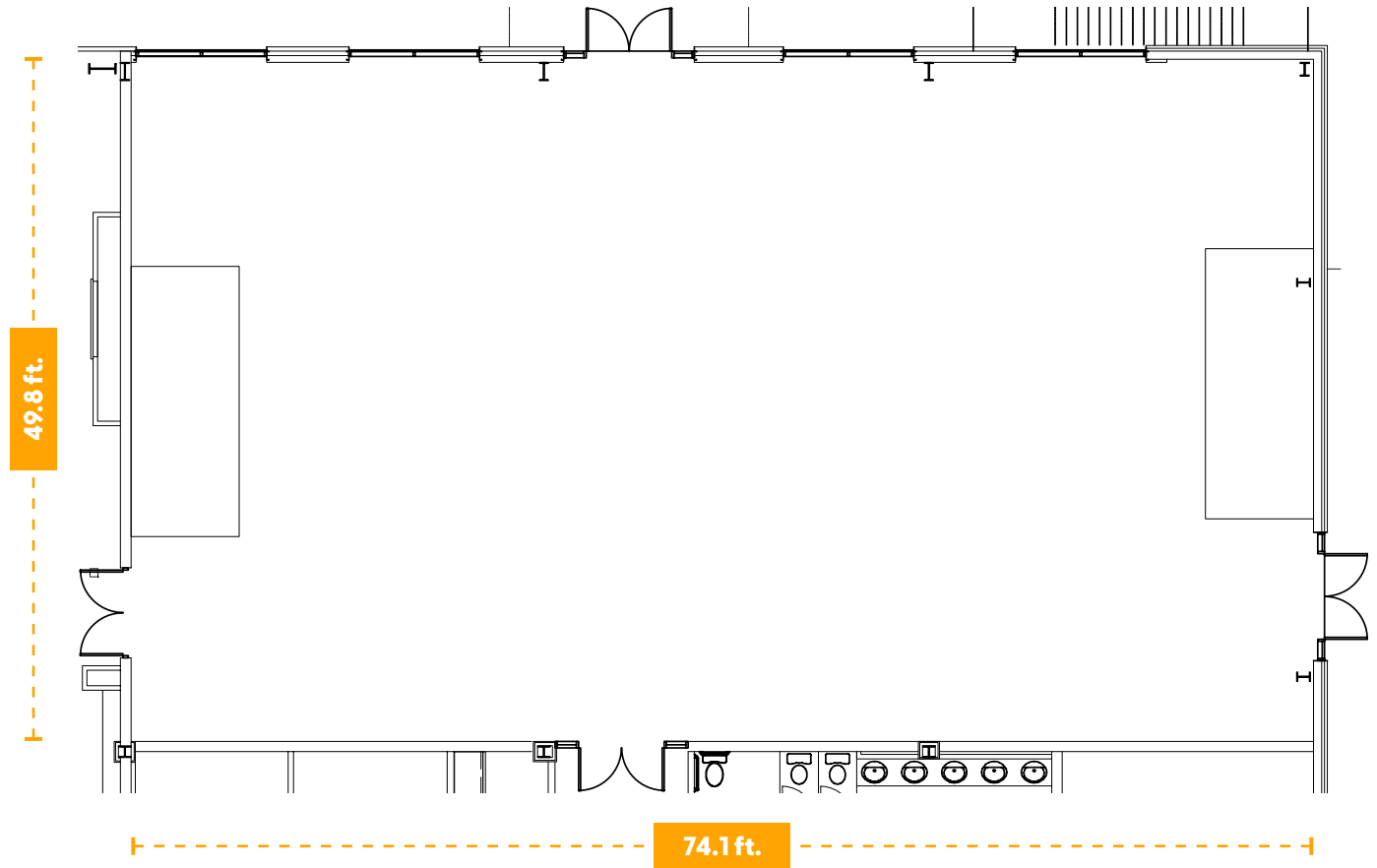

Ground Floor Plan

Auditorium B



## Multipurpose Room A

If you are looking for a breakout room for conferences or need a daily meeting space for a small get together. This Multipurpose Room has easy access being located on our main room, right off our grand lobby.

### Primary Use:

- + Conference Breakout Addon
- + Daily meeting rental
- + Wedding/Baby Shower

[Auditorium ▶](#)

[Multipurpose Room B ▶](#)

[Lobby Area ▶](#)

[Café Area ▶](#)

[Auditorium B ▶](#)

[Greenroom B ▶](#)

[Greenroom A ▶](#)

[Explore: Upper Floor Plan ▶](#)

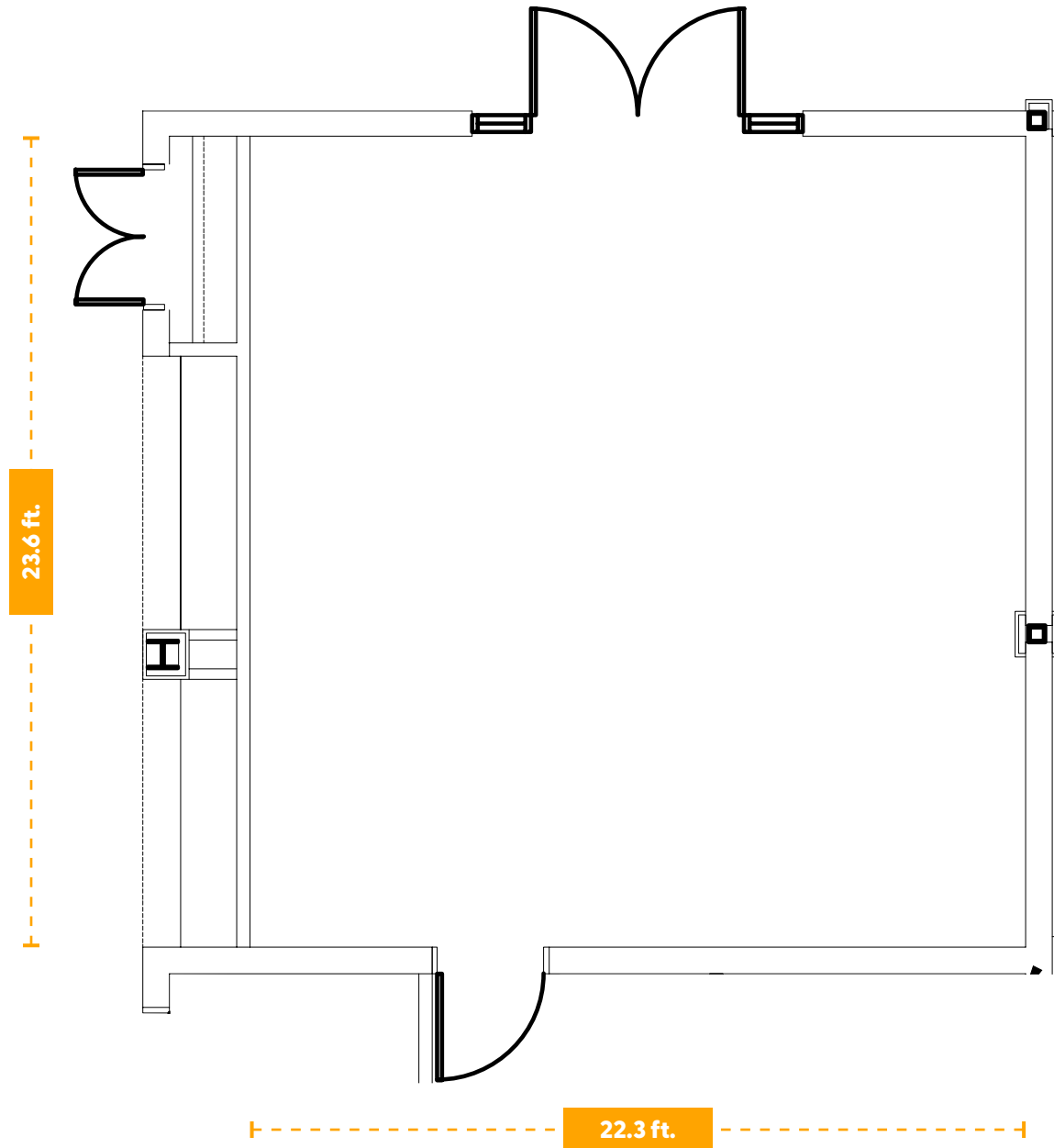

Ground Floor Plan

Multipurpose Room A

## Greenroom B

Our spacious greenrooms offer a quiet area to prepare or relax for your speaker and/or team. Included as part of our main auditorium rental these rooms are located backstage and accessible through our loading dock area. They also include access to private restrooms that include showers.

### Primary Use:

- + Included with Main Auditorium rental
- + Small meeting

[Auditorium](#) ▶

[Multipurpose Room B](#) ▶

[Lobby Area](#) ▶

[Café Area](#) ▶

[Auditorium B](#) ▶

[Multipurpose Room A](#) ▶

[Greenroom A](#)

[Explore: Upper Floor Plan](#) ▶

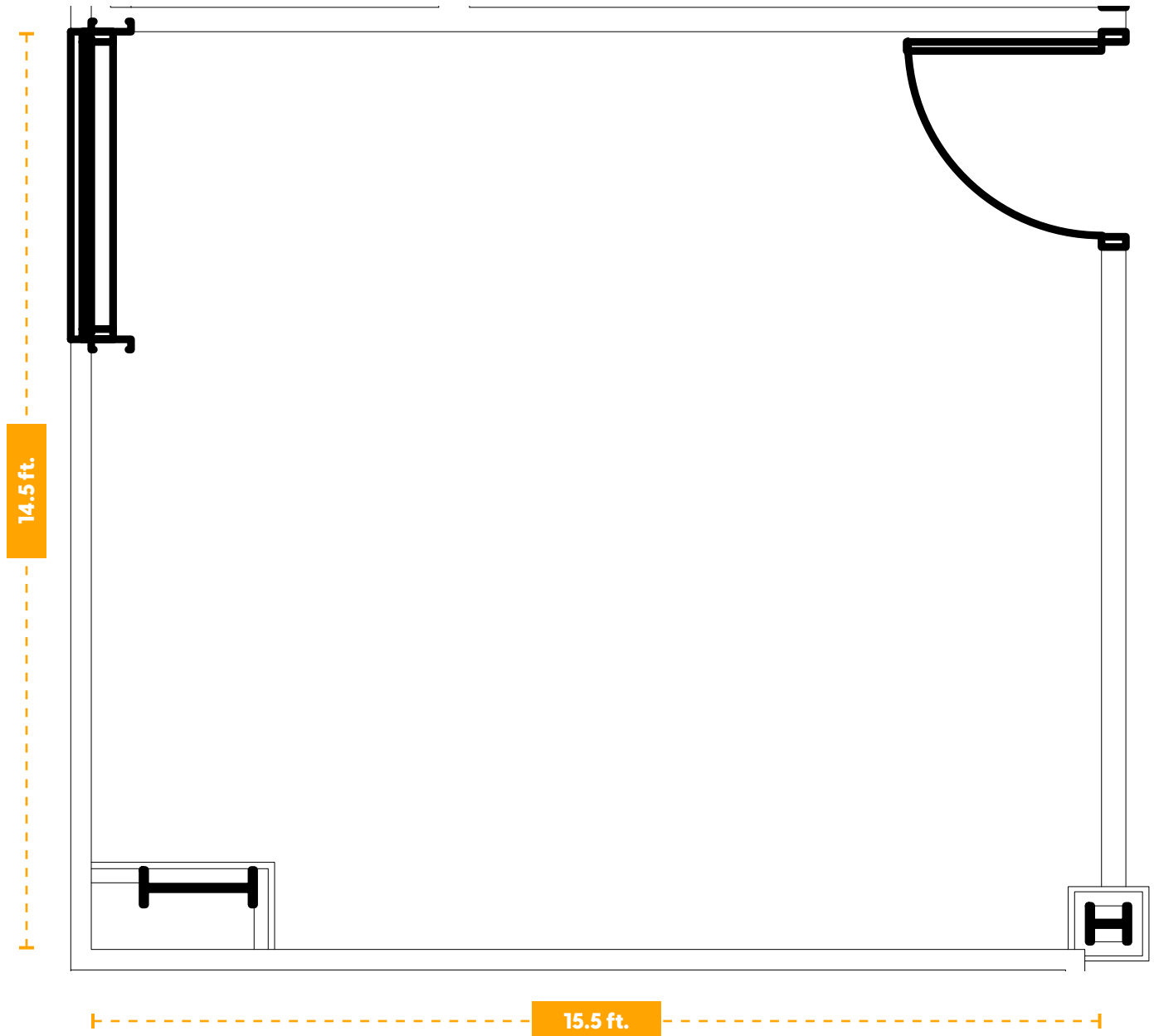

Ground Floor Plan

Greenroom B

## Greenroom A

Our spacious greenrooms offer a quiet area to prepare or relax for your speaker and/or team. Included as part of our main auditorium rental these rooms are located backstage and accessible through our loading dock area. They also include access to private restrooms that include showers.

### Primary Use:

- + Included with Main Auditorium rental
- + Small meeting

[Auditorium](#) ▶

[Multipurpose Room B](#) ▶

[Lobby Area](#) ▶

[Café Area](#) ▶

[Auditorium B](#) ▶

[Multipurpose Room A](#) ▶

[Greenroom B](#) ▶

[Explore: Upper Floor Plan](#) ▶

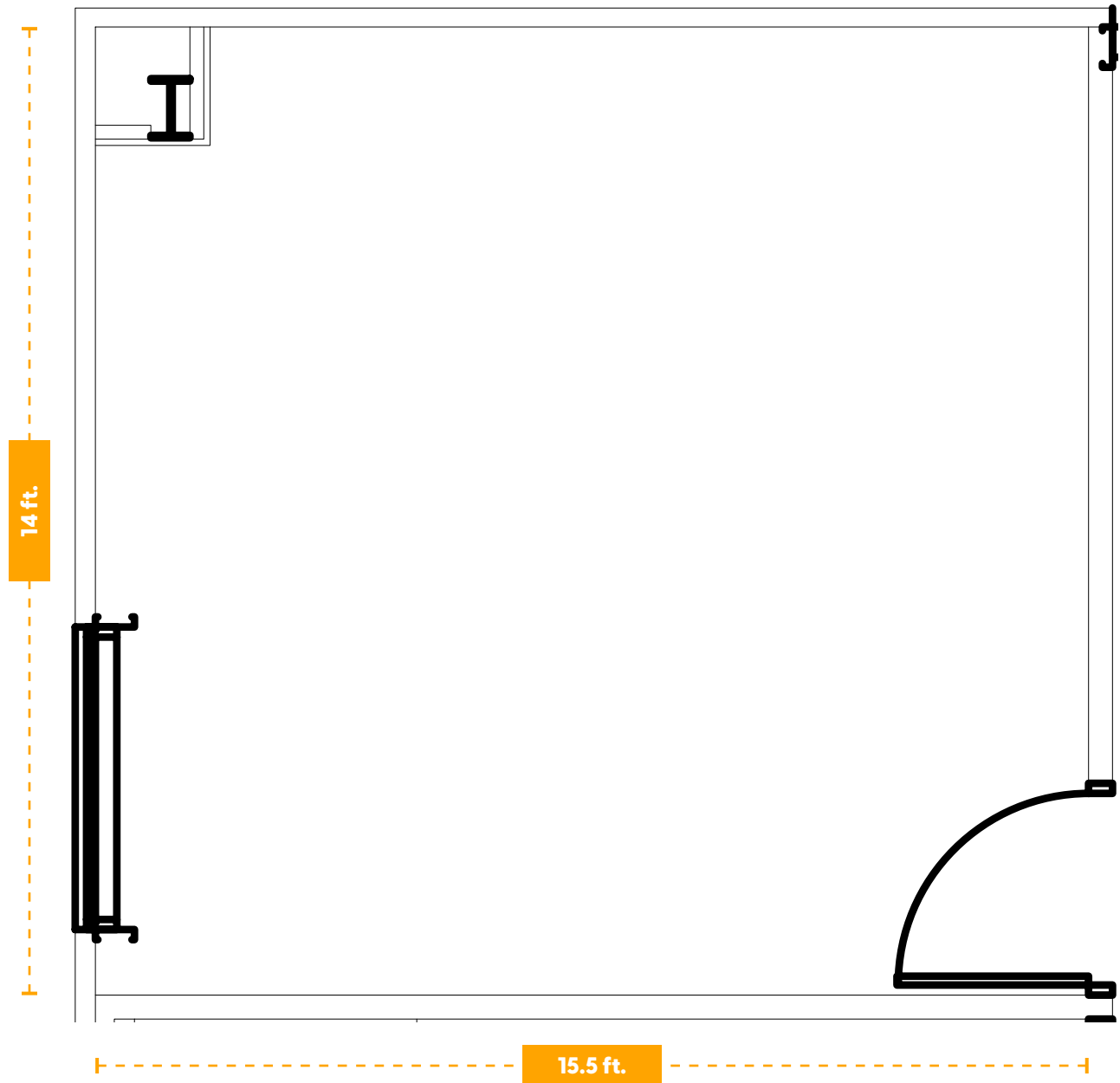

Ground Floor Plan

Greenroom A

## Meeting Room A

Our second floor has access to a number of smaller meeting rooms that can be used as breakout rooms for your conference. These rooms are also available as a daily rental for small meetings. Rooms range in size.

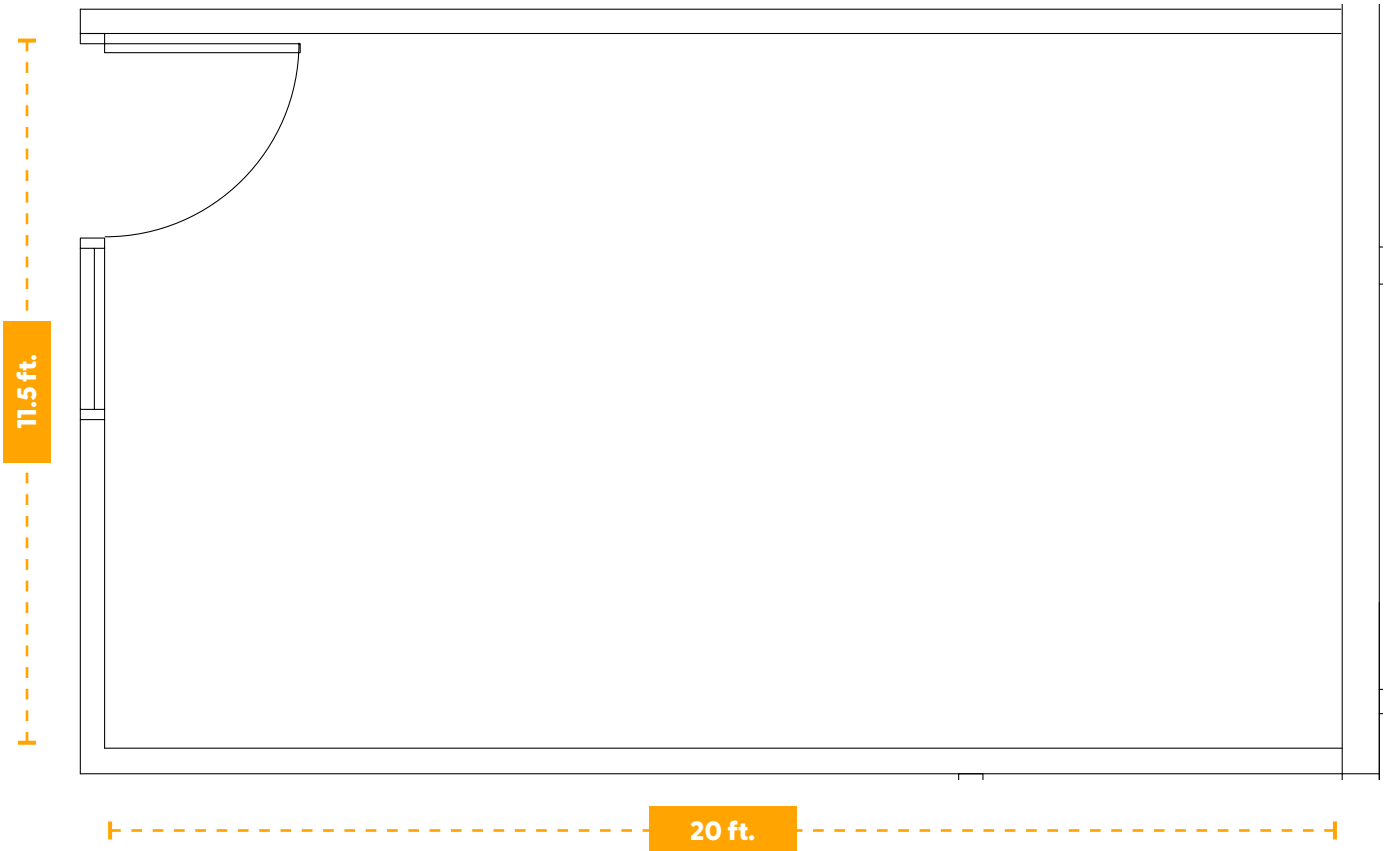

[Meeting Room B ▶](#)

[Meeting Room C ▶](#)

[Meeting Room D ▶](#)

[Meeting Room E ▶](#)

[Executive Boardroom ▶](#)

[Future Rental Space ▶](#)

[Explore: Ground Floor Plan ▶](#)

Upper Floor Plan

Meeting Room A

## Meeting Room B

Our second floor has access to a number of smaller meeting rooms that can be used as breakout rooms for your conference. These rooms are also available as a daily rental for small meetings. Rooms range in size.

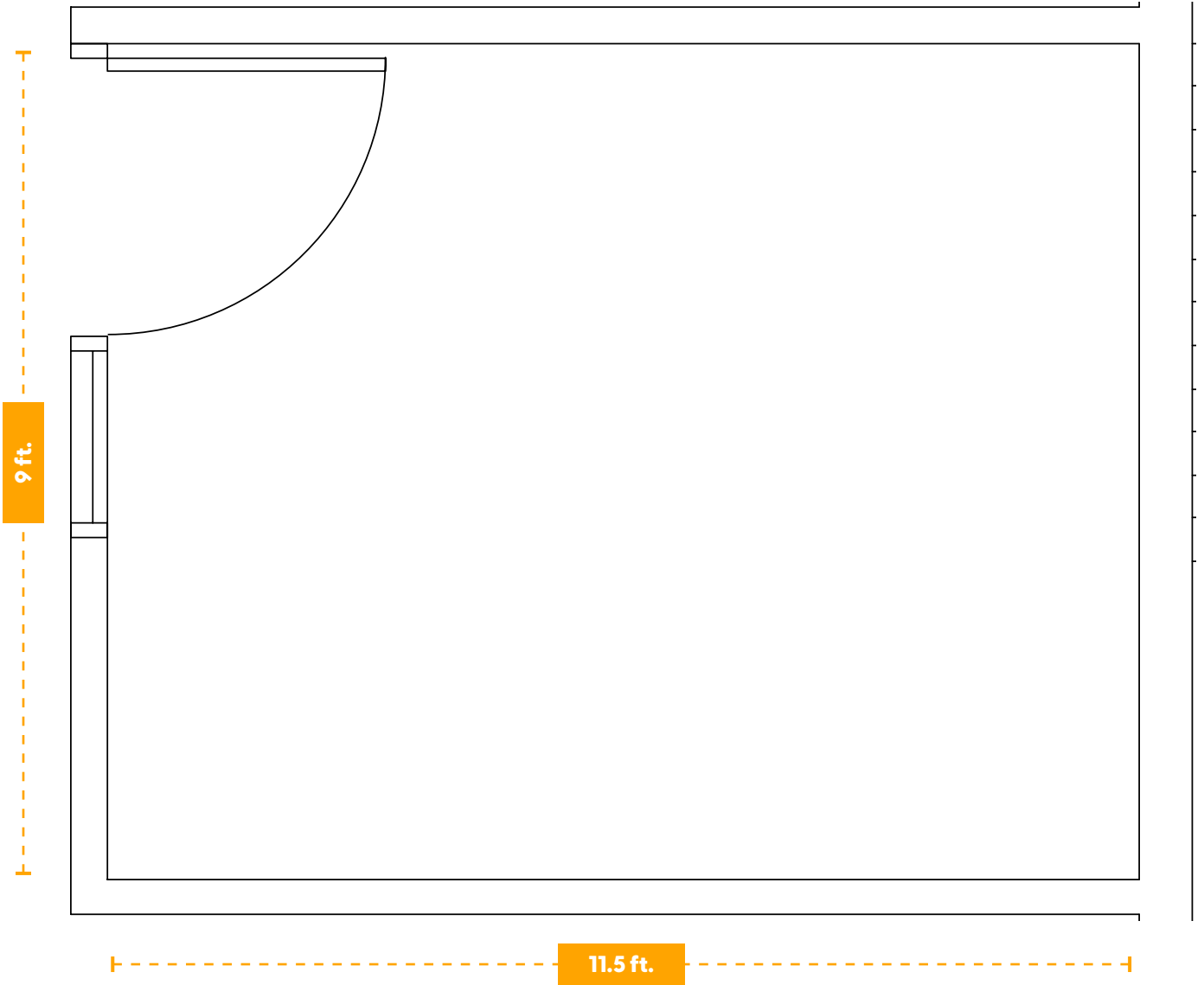

[Meeting Room A](#) ▶

[Meeting Room C](#) ▶

[Meeting Room D](#) ▶

[Meeting Room E](#) ▶

[Executive Boardroom](#) ▶

[Future Rental Space](#) ▶

[Explore: Ground Floor Plan](#) ▶

Upper Floor Plan

Meeting Room B

## Meeting Room C

Our second floor has access to a number of smaller meeting rooms that can be used as breakout rooms for your conference. These rooms are also available as a daily rental for small meetings. Rooms range in size.

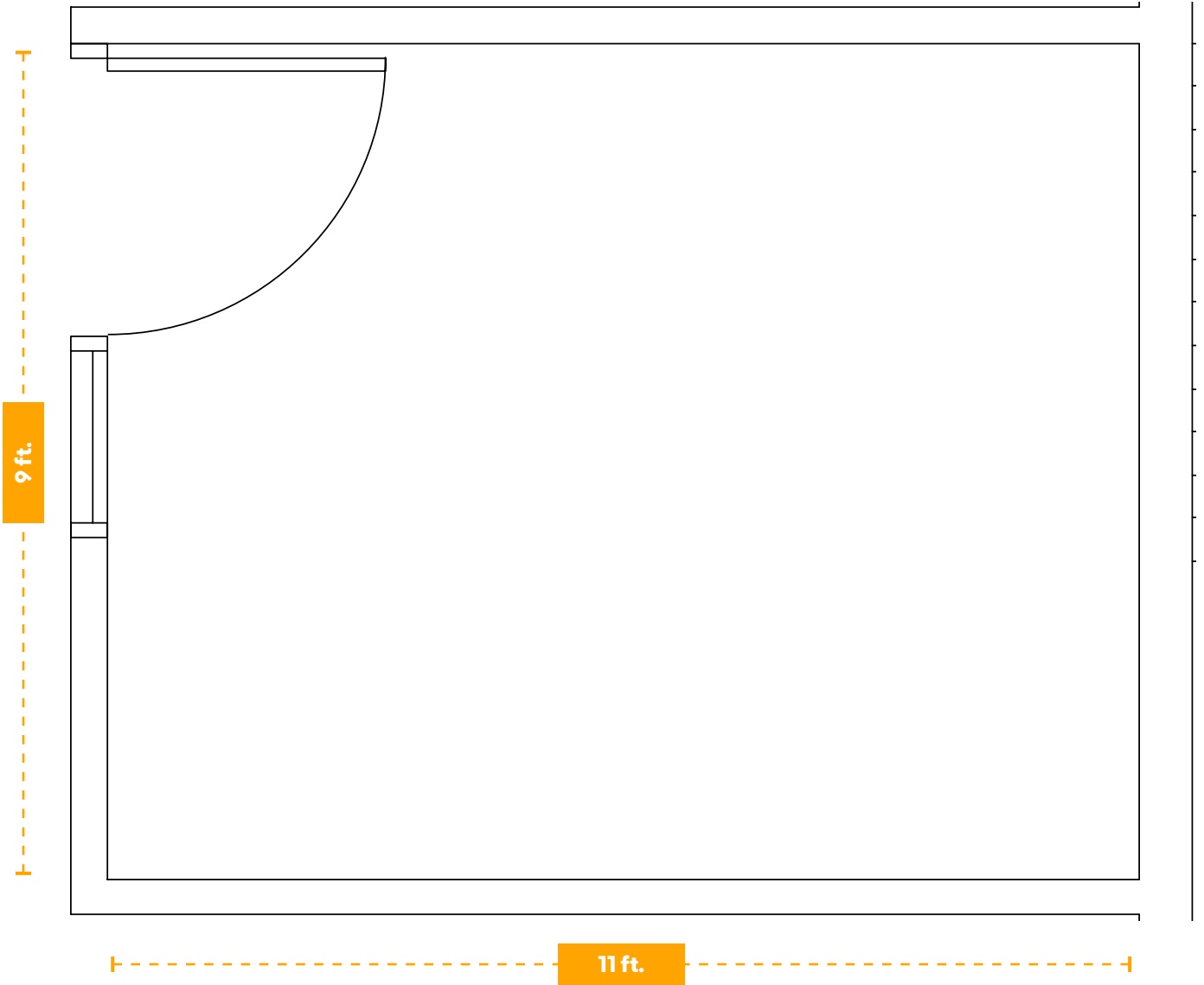

[Meeting Room A](#) ▶

[Meeting Room B](#) ▶

[Meeting Room D](#) ▶

[Meeting Room E](#) ▶

[Executive Boardroom](#) ▶

[Future Rental Space](#) ▶

[Explore: Ground Floor Plan](#) ▶

Upper Floor Plan

Meeting Room C

## Meeting Room D

Our second floor has access to a number of smaller meeting rooms that can be used as breakout rooms for your conference. These rooms are also available as a daily rental for small meetings. Rooms range in size.

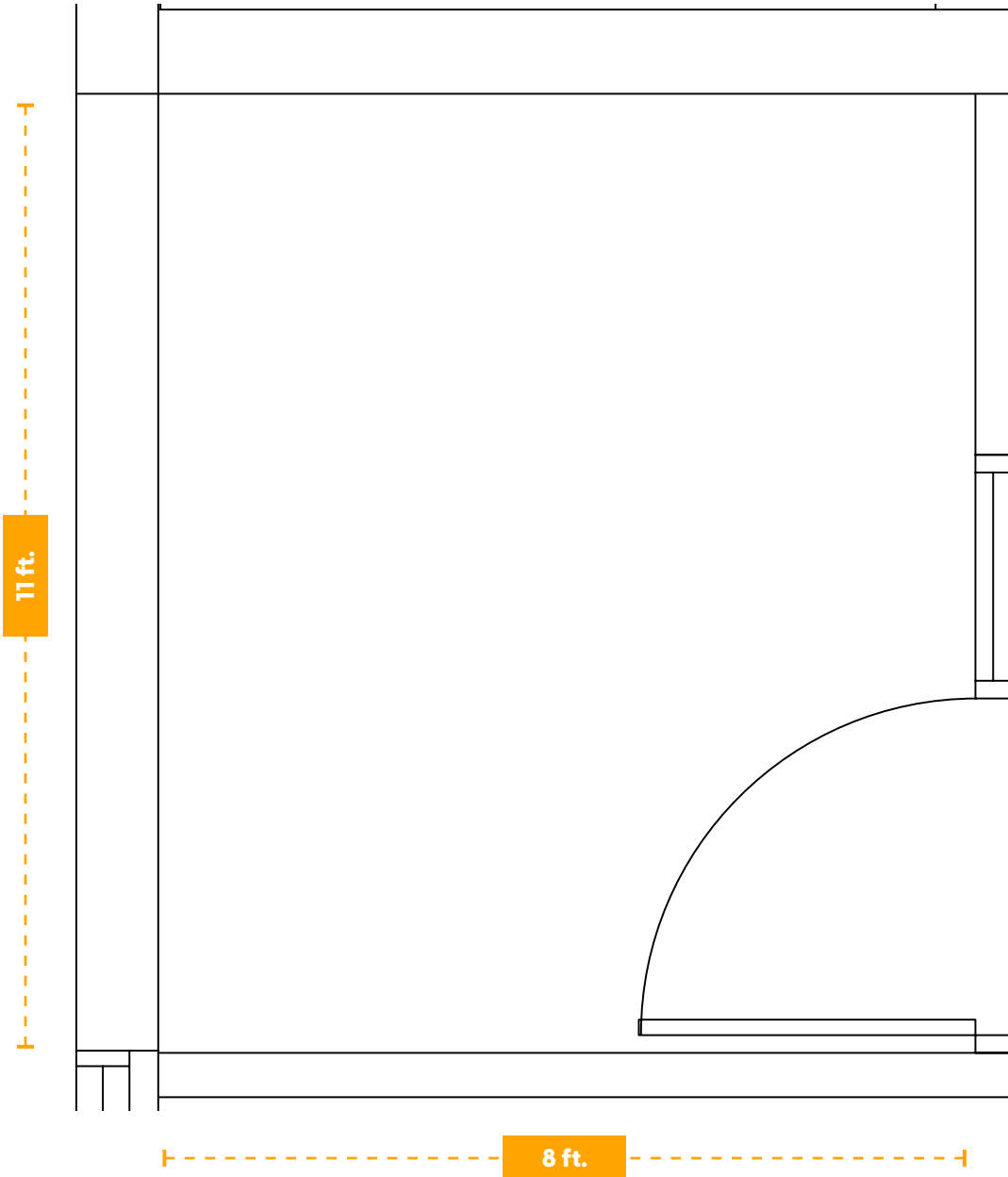

[Meeting Room A](#) ▶

[Meeting Room B](#) ▶

[Meeting Room C](#) ▶

[Meeting Room E](#) ▶

[Executive Boardroom](#) ▶

[Future Rental Space](#) ▶

[Explore: Ground Floor Plan](#) ▶

Upper Floor Plan

Meeting Room D

## Meeting Room E

Our second floor has access to a number of smaller meeting rooms that can be used as breakout rooms for your conference. These rooms are also available as a daily rental for small meetings. Rooms range in size.

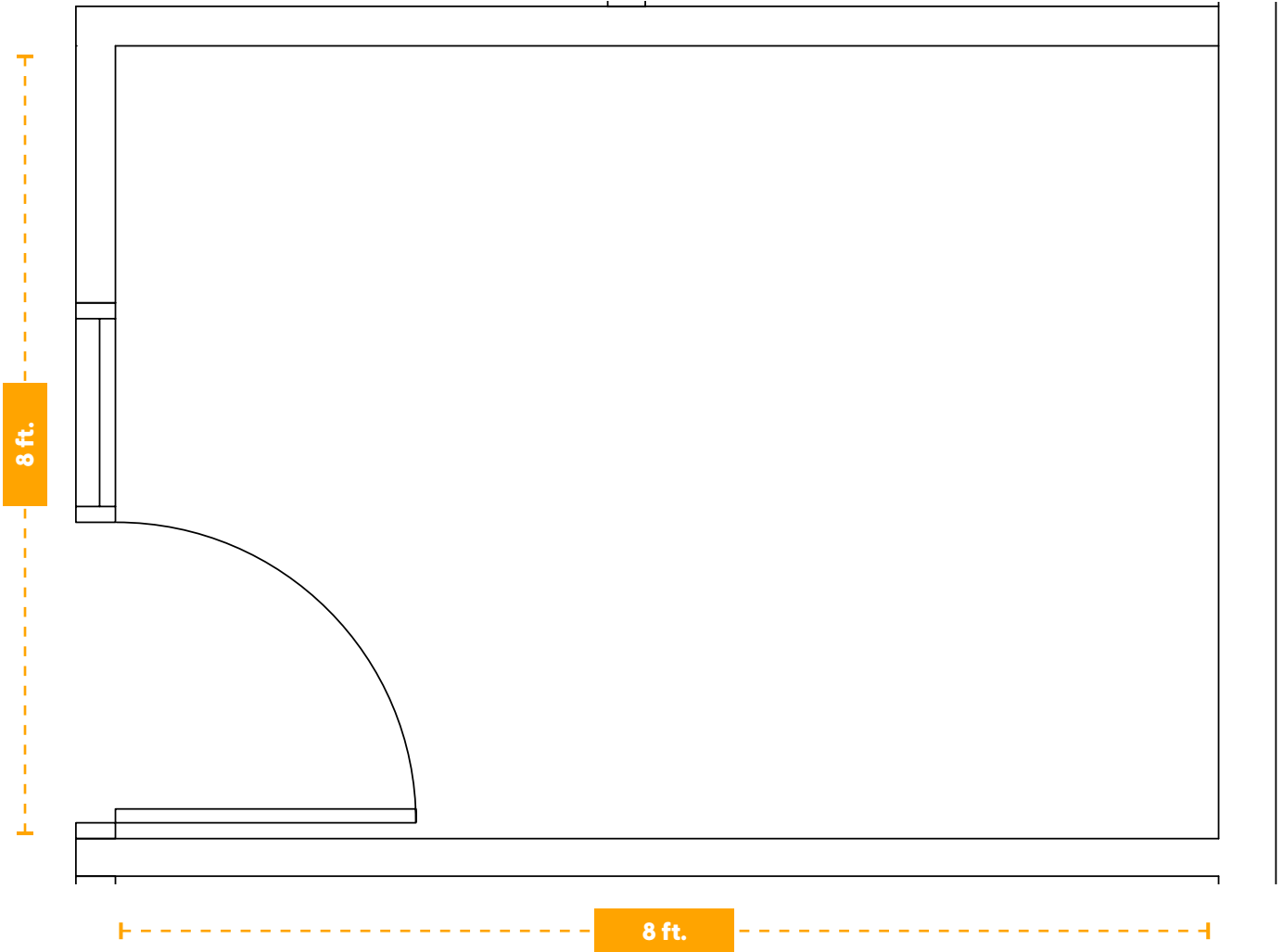

[Meeting Room A](#) ▶

[Meeting Room B](#) ▶

[Meeting Room C](#) ▶

[Meeting Room D](#) ▶

[Executive Boardroom](#) ▶

[Future Rental Space](#) ▶

[Explore: Ground Floor Plan](#) ▶

Upper Floor Plan

Meeting Room E



## Executive Boardroom

Our Executive Boardroom is the perfect spot to host a smaller meeting. Equipped with a TV this room can host up to 30 people. Located on the second floor this room boast large windows to let in natural light. Elevator access is available.

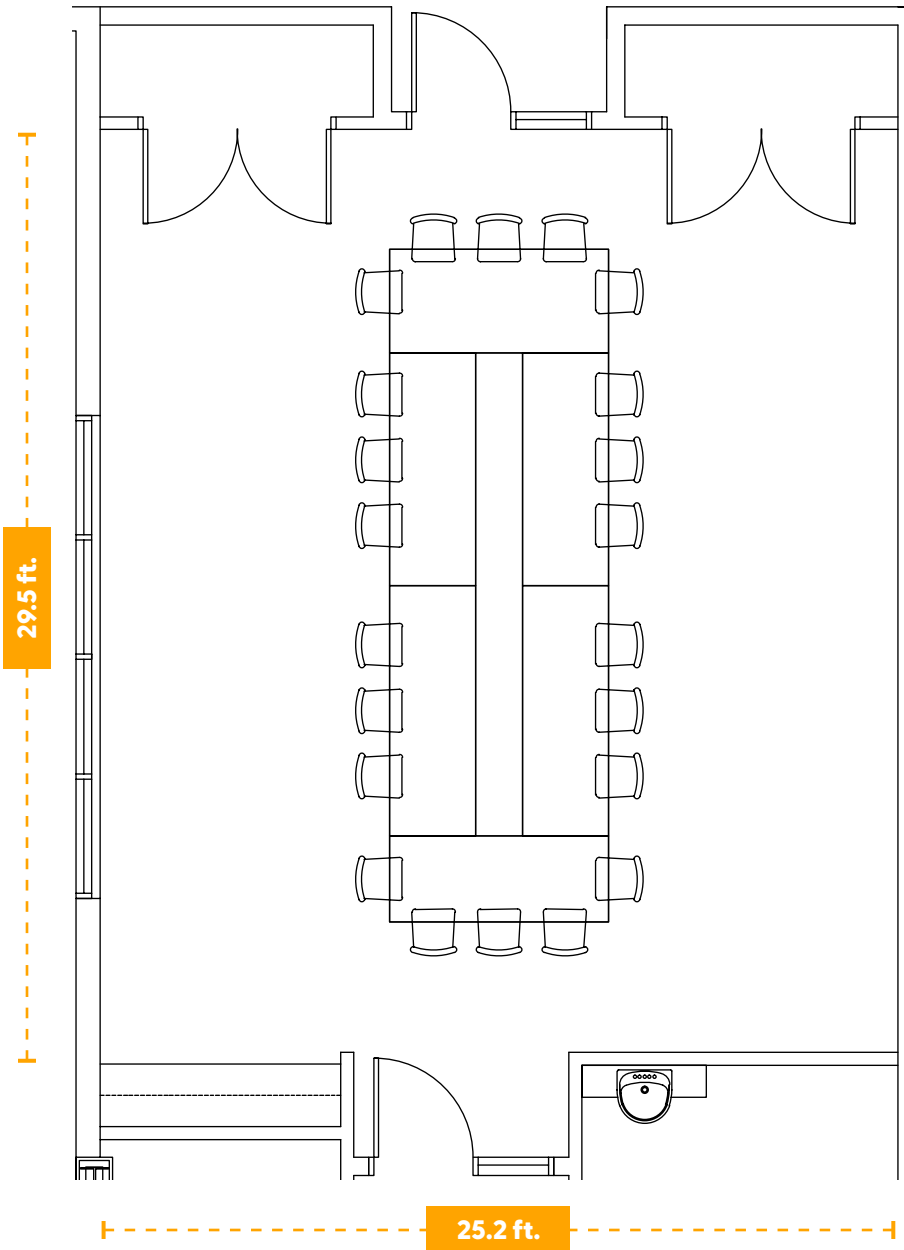

[Meeting Room A](#) ▶

[Meeting Room B](#) ▶

[Meeting Room C](#) ▶

[Meeting Room D](#) ▶

[Meeting Room E](#) ▶

[Future Rental Space](#) ▶

[Explore: Ground Floor Plan](#) ▶

Upper Floor Plan

Executive Boardroom

## Future Rental Space

Coming soon.

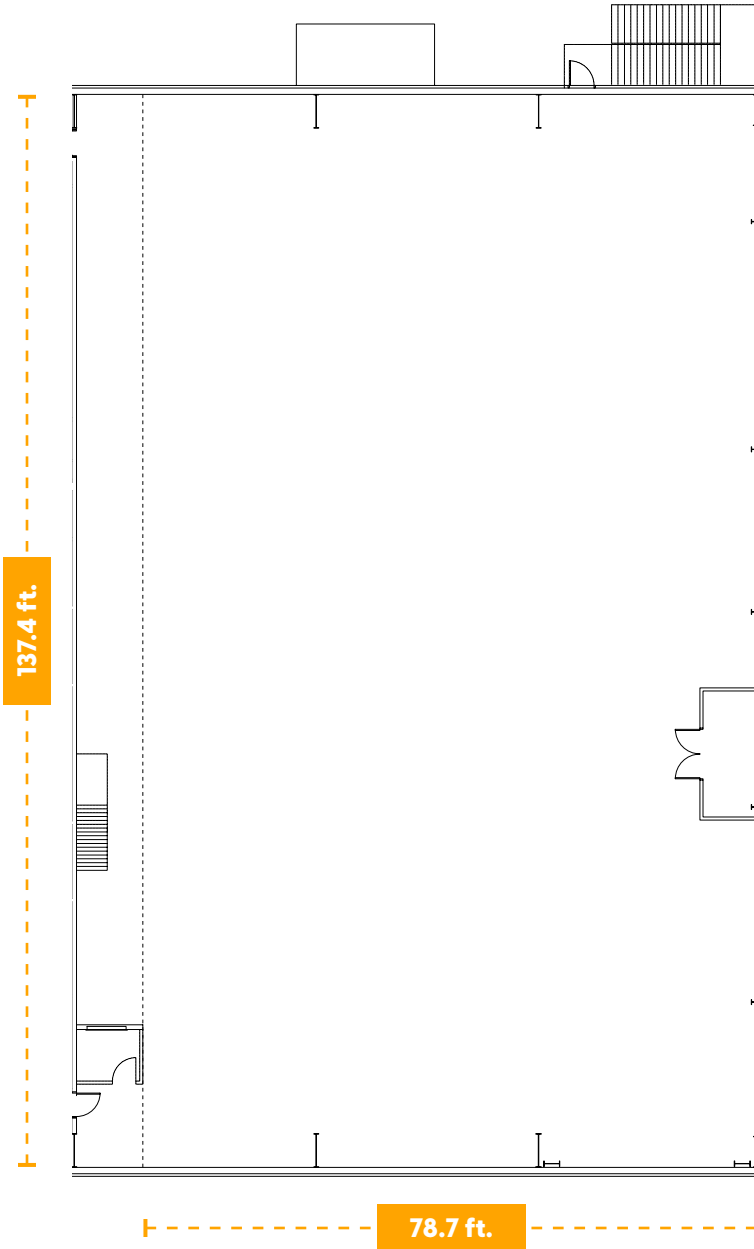

[Meeting Room A](#) ▶

[Meeting Room B](#) ▶

[Meeting Room C](#) ▶

[Meeting Room D](#) ▶

[Meeting Room E](#) ▶

[Executive Boardroom](#) ▶

[Explore: Ground Floor Plan](#) ▶

Upper Floor Plan

Future Rental Space



## Location

---

Central Niagara  
680 York Rd.  
Niagara on the Lake  
Ontario L0S 1J0

## Contact

---

[rentals@centralniagara.org](mailto:rentals@centralniagara.org)  
(289) 646-0907